

3 CIRCUIT RAIL



MATERIAL

Copper+Aluminum

STANDARD COLORS

Black (RAL 9005), White (RAL 9016)

SOURCE INFORMATION

INPUT VOLTAGE 120V/20A

IP 20

UNIT WEIGHT

0.36 lb/ft

Fixture type:

Job information:

MOUNTING

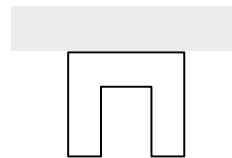

Surface Mount

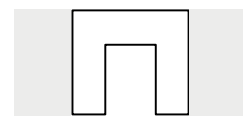

Recessed mount

DIMENSIONS

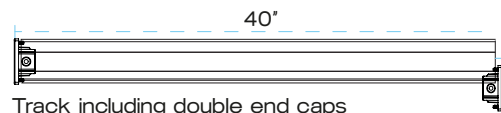
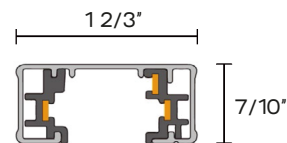

Track including double end caps

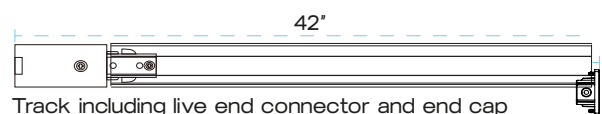

Track including live end connector and end cap

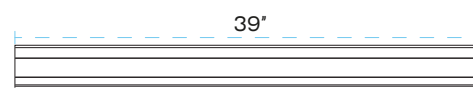

Only track

TRACK RAIL

INSTALLATION

Please read carefully before installing

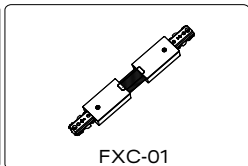
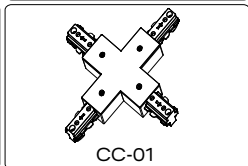
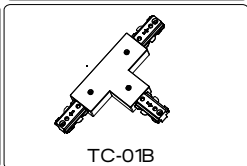
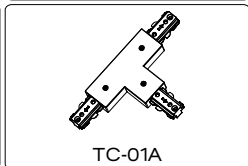
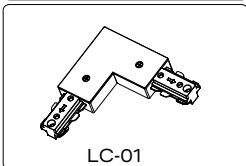
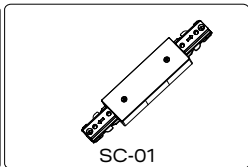
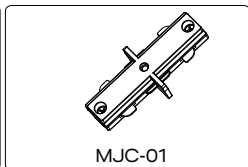
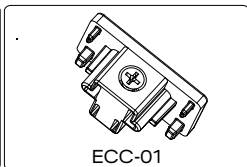
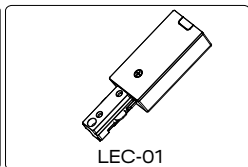
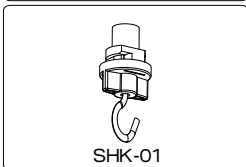
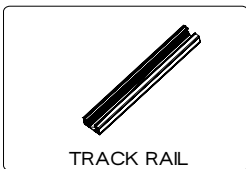
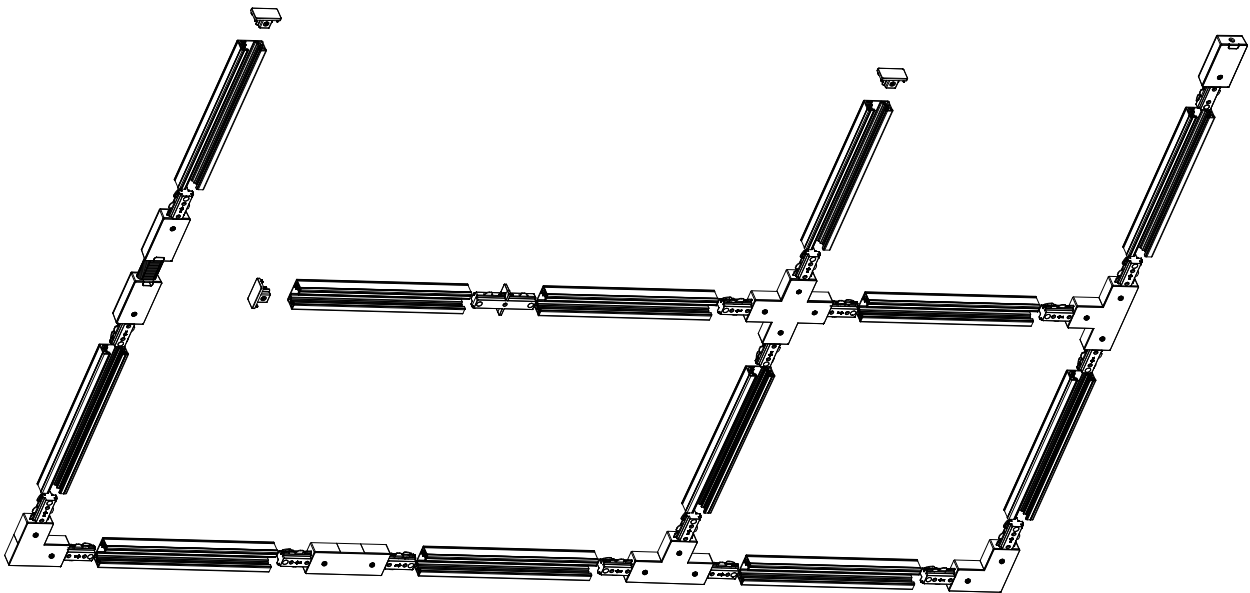

PATTERN CONFIGURATOR

Use grid below to sketch desired pattern

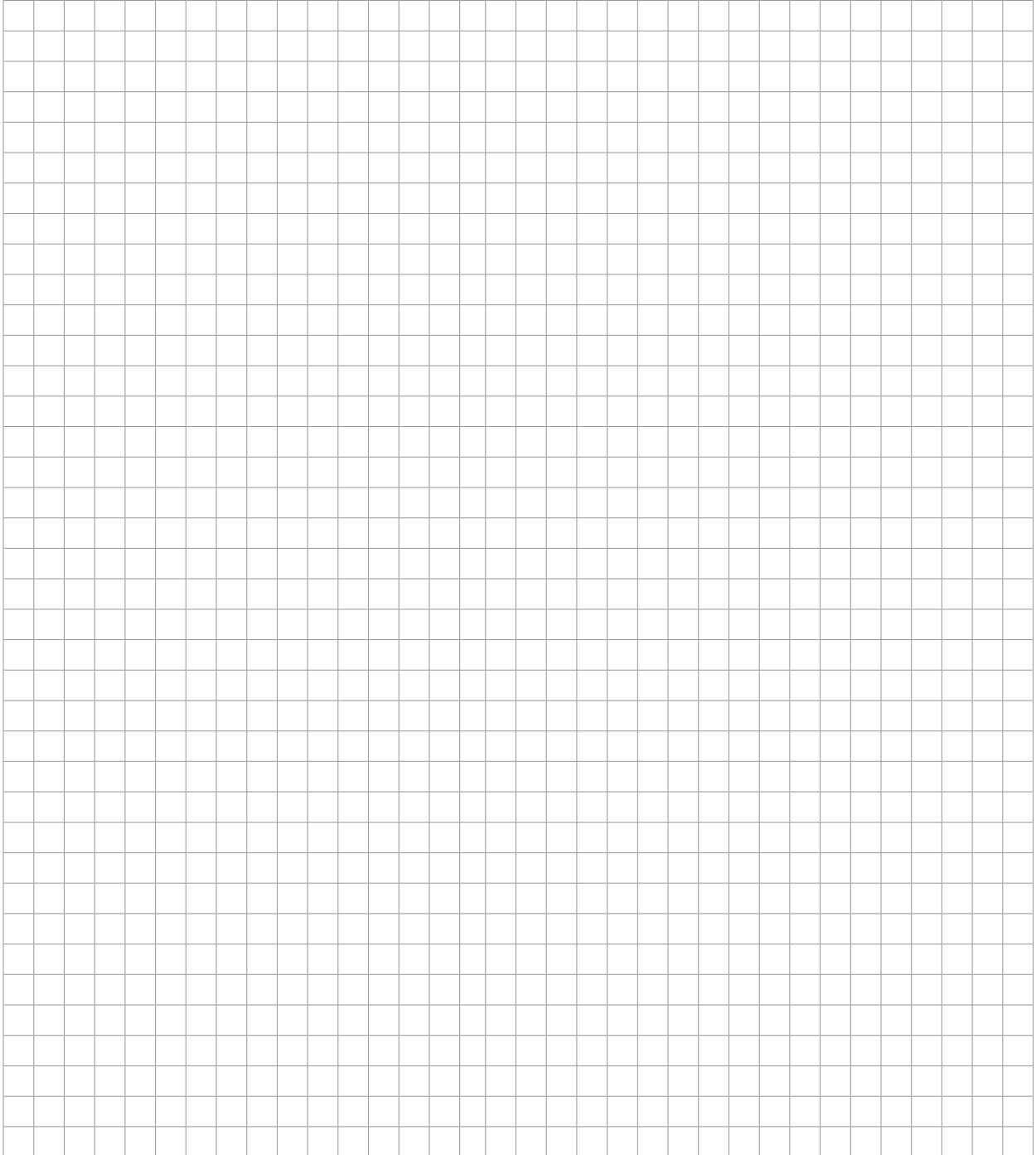

TRACK RAIL

INSTALLATION

Please read carefully before installing

Surface Mount

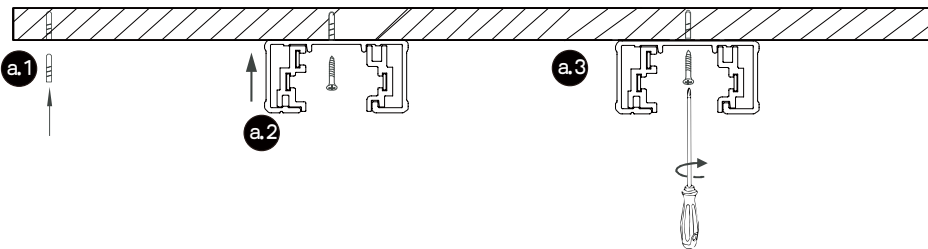
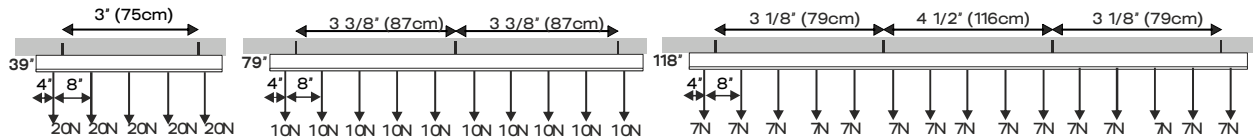

According to the installation condition to confirm screws, or use the material package included with the track

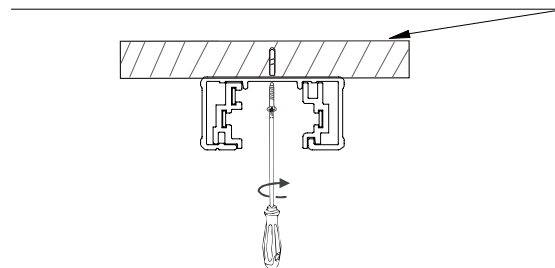

CONNECTING DIAGRAM

3 wires track system



120V 20A Max.

INSTALLATION

Please read carefully before installing

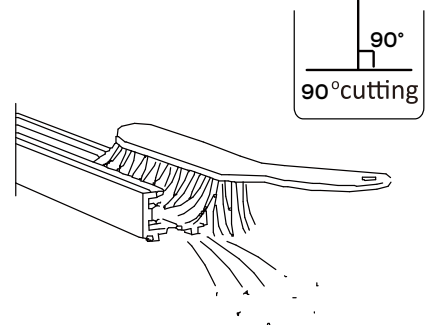
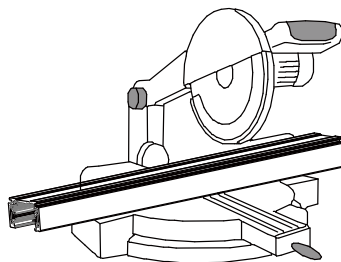
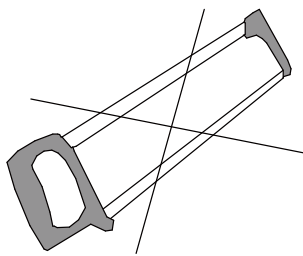
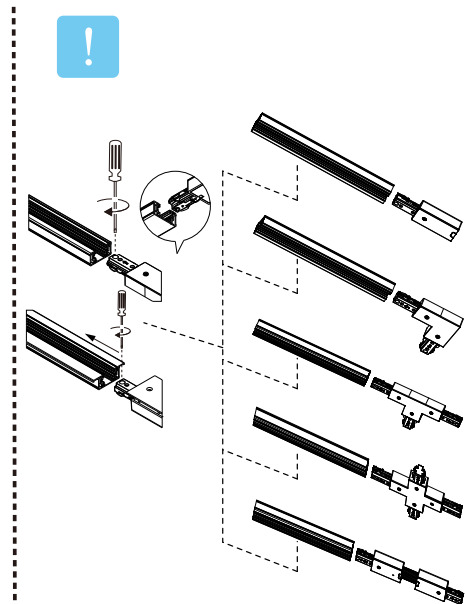
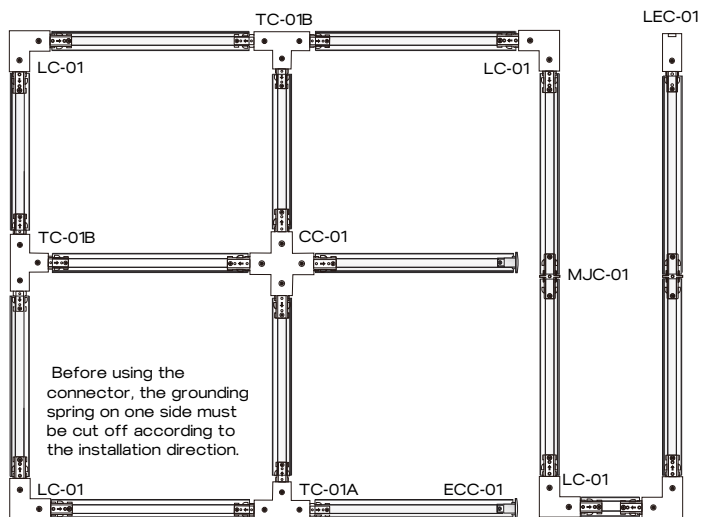

TROUBLESHOOTING

If the track system is out of power, or the voltage value is abnormal, please check whether the following abnormal conditions exist in the installation:

1. Please ensure the live end connector is installed correctly, and the metal springs are connected to the track copper wires.
2. Please ensure the terminals "N" "L" "G" inside of live end are wired correctly and firmly.
3. Please ensure the ground spring on one side is cut.
4. Please ensure the track is connected in the correct direction.
5. Please ensure all the wiring firmly and no looseness or detachment.

DISCLAIMER

1. It is forbidden to apply paint, glue, etc. to this product.
2. This product is suitable for indoors, not outdoors.
3. It is recommended to use Mercury track system, compatibility with other track system is not guaranteed.
4. If the structure or wiring of this product is not used/modified according to the instructions, resulting in damage to this product or related products, Mercury doesn't continue to maintain the after-sales commitment.
5. Product optimization and version upgrade will not be prior noticed. Please refer to the actual product received. If you have any questions, please contact our sales staff in time.
6. Mercury reserves the right of final interpretation of this product.