

 **WARNING**

1. Don't use in location that exists with vibration, impact corrosion or flammable gas and dust.
2. Don't use in location that is in high temperature as like sauna.
3. Only use designated LED.
4. Don't modify and change assembly of luminaires.
5. Do not turn on when lighting fixture is damaged.
6. Connect power source line to LED driver certified according to en/iec 60742.

 **CAUTION**

1. When removing or attaching the reflector, do not touch it with your bare hands.  
(※ Clean gloves or new gloves should be used since fingerprints may remain on the reflector)
2. The luminaire is not suitable for outdoor installation.
3. To avoid risks fire and shock hazards, if this luminaire has a damaged external flexible wiring, it must only be replaced by the manufacturer, his service agent or qualified technician.
4. A dampened soft cloth is to be used.
5. Use a soft cloth and a standard pH neutral, alcohol free non-scouring detergent.  
Ensure wire color : (+) red, (-) black
6. Use a soft cloth and a standard pH neutral, non scouring detergent.
7. The luminaire must be switched-off and cool before being cleaned.  
Note : Regular cleaning is essential. The interval and method will depend on the mounting location, the mounting situation and ambient conditions.
8. Do not connect to the Branch circuit with other lighting fixtures which have different light source like discharge lamp & etc.



This marking shown on the product or its literature, indicates that it should not be disposed with other household wastes at the end of its working life. To prevent possible harm to the environment or human health from uncontrolled waste disposal, please separate this from other types of wastes and recycle it responsibly to promote the sustainable reuse of material resources.

Household users should contact either the retailer where they purchased this product, or their local government office, for details of where and how they can take this item for environmentally safe recycling.  
Business users should contact their supplier and check the terms and conditions of the purchase contract, This product should not be mixed with other commercial wastes for disposal.

※ Before you use, please read this information and use correctly.



# Product Family: QUASAR

## INSTALLATION INSTRUCTIONS SAFETY INFORMATION

### Luminaire Assembly **QSR-14-AD-TWF** (IC TYPE)

※ To change size depending on options.

**THIS PRODUCT MUST BE INSTALLED IN ACCORDANCE WITH THE APPLICABLE INSTALLATION CODE BY A PERSON FAMILIAR WITH THE CONSTRUCTION AND OPERATION OF THE PRODUCT AND THE HAZARDS INVOLVED."CONSULT A QUALIFIED ELECTRICIAN TO ENSURE CORRECT BRANCH CIRCUIT CONDUCTOR**

**MAKE SURE THE POWER SUPPLY IS TURNED OFF AT THE CIRCUIT BREAKER BEFORE MAKING THE ELECTRICAL CONNECTION.**

**THE ELECTRICAL CONNECTION AND INSTALLATION CAN BE DONE FROM THE ROOM SIDE.**

## ELECTRICAL CONNECTIONS:

1. Push the luminaire to remove, press down as it has springs, hold the springs and remove.
2. Disconnect from the intermediate connector
3. Access the driver and push the clip to remove it from its position.
4. Open the junction box, pushing the clip.
5. Connect the line conductors to the driver conductors.

Black - voltage  
White - neutral  
Green - ground wire

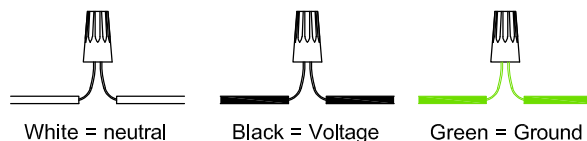

**NOTE GROUNDING** : Many structures are grounded through steel conduit. In this case.

6. Cover the connections with wire nuts.
7. Reconnect the intermediate connector and secure the luminaire in place.
8. Secure the luminaire springs, and the ring (depending on model).

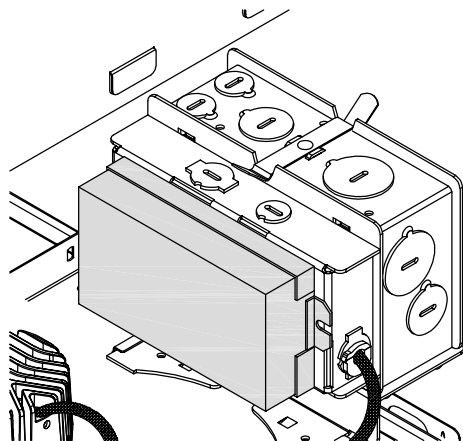

## INSTALLATION:

- Install so Hanger Bar flanges are positioned as shown.

### - For wood joist ceilings:

Flush with the bottom side of the joist, enabling drywall to be unobstructively installed, and the plaster frame in direct contact with the drywall.

Use bar hangers to attach fixture between ceiling joists. Each end of the bar hanger is equipped with a nail-in barbed tab. Additional hardware such as screws or nails may be used if extra support is necessary.

The bar hangers can be mounted at either side by unscrewing / screwing the screws.

For steel studs, use steel piercing screws in place of nails or barbed tabs.

Remove shipping screw from underneath side of plaster frame.

### - For suspended or T-Bar ceiling: Flush with the top side of the ceiling tile.

If mounting to a T-Bar type ceiling, mount fixture onto grid by placing notches on the bottom of each end of the bar hanger over the grid.

Tie fixture to grid with structural wire going through both the circular knockout on the end of the bar hanger and nearest accompanying knockout on the ceiling grid.

**NOTE:** It is imperative to tie down the fixture to prevent the fixture from being pushed above the ceiling during reflector installation.

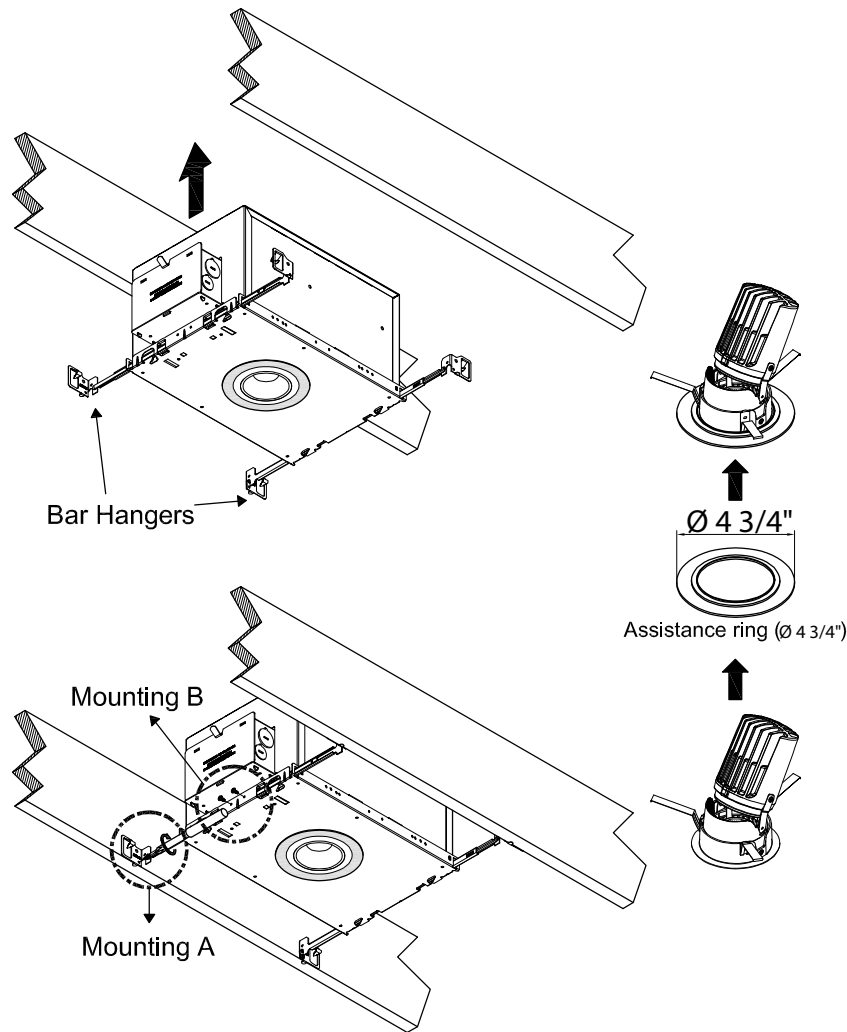

[Mounting A]

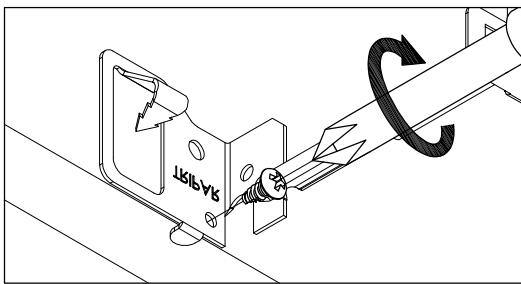

[Mounting B]

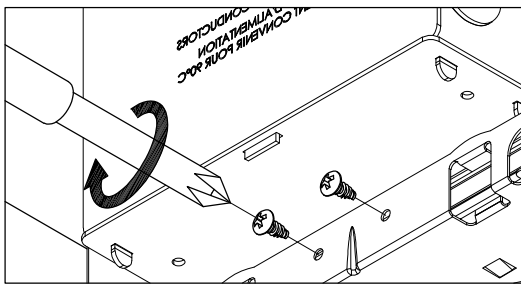

Secure space so that wiring can be made possible.

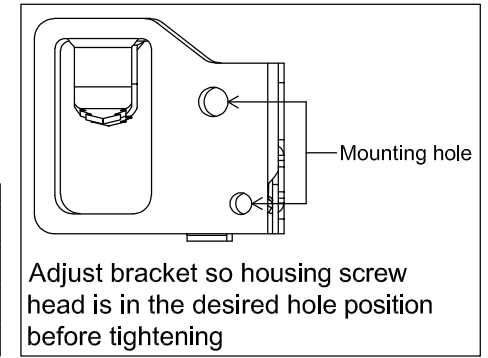
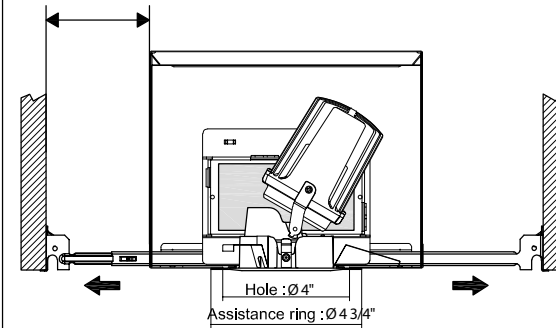

► Junction Box connection

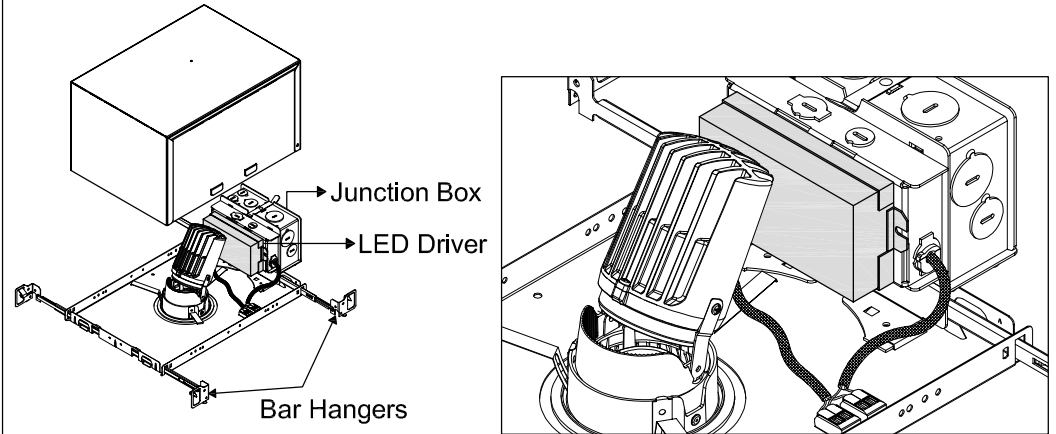

▲ Caution

Be sure to select correct hole position for intended trim assembly. Changing hole position is not possible after ceiling is installed.

► Hole size by model

