

**⚠ WARNING**

1. Don't use in location that exists with vibration, impact corrosion or flammable gas and dust.
2. Don't use in location that is in high temperature as like sauna.
3. Only use designated LED.
4. Don't modify and change assembly of luminaires.
5. Do not turn on when lighting fixture is damaged.
6. Connect power source line to LED driver certified according to en/iec 607 42.

**⚠ CAUTION**

1. When removing or attaching the reflector, do not touch it with bare hands.  
(Clean gloves or new gloves should be used as fingerprints may be left on the reflector)
2. The luminaire is not suitable for outdoor installation.
3. To avoid fire and electric shock hazards, if this luminaire has damaged external flexible wiring, it should only be replaced by the manufacturer or its service agent.
4. Use a soft, damp cloth; and a standard nonalcoholic, pHneutral detergent.  
Make sure of the color of the wires : (+) red, (-) black.
5. The luminaire must be turned off and cool before cleaned.  
Note : Periodic cleaning is essential. The interval and method will depend on the mounting location, mounting situation and ambient conditions.
6. Do not connect to the branch circuit with other lighting fixtures which have different light source like discharge lamp & etc.



This marking shown on the product or its literature, indicates that it should not be disposed with other household wastes at the end of its working life. To prevent possible harm to the environment or human health from uncontrolled waste disposal, please separate this from other types of wastes and recycle it responsibly to promote the sustainable reuse of material resources.

Household users should contact either the retailer where they purchased this product, or their local government office, for details of where and how they can take this item for environmentally safe recycling.  
Business users should contact their supplier and check the terms and conditions of the purchase contract, This product should not be mixed with other commercial wastes for disposal.

**SAFETY MARKS**



The luminaire must not under and circumstances be covered with heat insulating covers or similar materials.

※ Before you use, please read this information and use correctly.



# Product Family: CONSTELLATION

## INSTALLATION INSTRUCTIONS

## SAFETY INFORMATION

### Luminaire Assembly

# CTL-10-DI-640-TFL

※ To change size depending on options.

## THE ELECTRICAL CONNECTION MUST BE MADE BY AN ELECTRICIAN

**MAKE SURE THE POWER SUPPLY IS TURNED OFF AT THE FUSE BOARD BEFORE MAKING THE ELECTRICAL CONNECTION.**

**THE ELECTRICAL CONNECTION AND INSTALLATION CAN BE DONE FROM THE ROOM.**

## ELECTRICAL CONNECTIONS:

1. Open the junction box
2. Connect the wires coming out of the junction box to the power supply accordingly.

Black - voltage  
White - neutral  
Green - ground wire

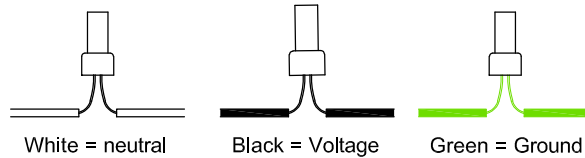

**NOTE GROUNDING :** Many structures are grounded through steel conduit. In this case, if there is no grounding wire, leave the green wire of the green wire from the fixture unattached.

3. Cover the connections with safety caps.
4. Finally continue with the installation.

### ► Electrical Connections

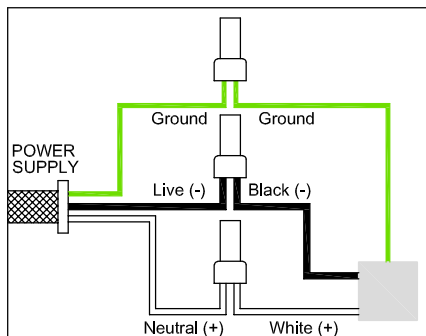

### ► Wiring Diagram

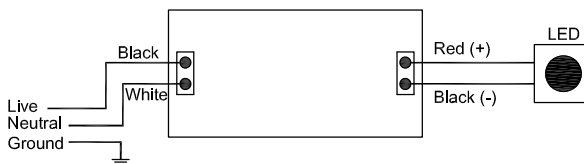

**[Connect wires accordingly]**

- Black (120-277V) = Supply Voltage
- White = Neutral
- Green or copper wire = Grounding Junction Box Wire

## DRIVER CONNECTION AND SPACING

1. Keep the distance between the light fixture and the driver as much as possible.
2. The inside of the ceiling where the lighting fixture is to be installed, it is necessary to secure a minimum space for heat dissipation.

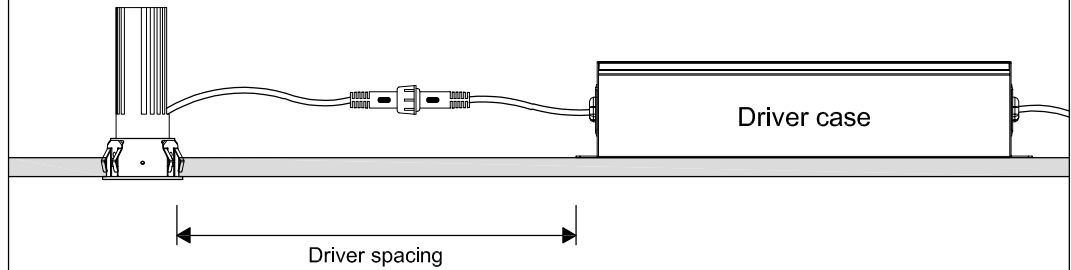

## DRIVER ELECTRIC DIAGRAM

1. Detect the heat from the light fixture and lower the temperature.
2. Connect the driver and lighting fixtures through the terminal block.

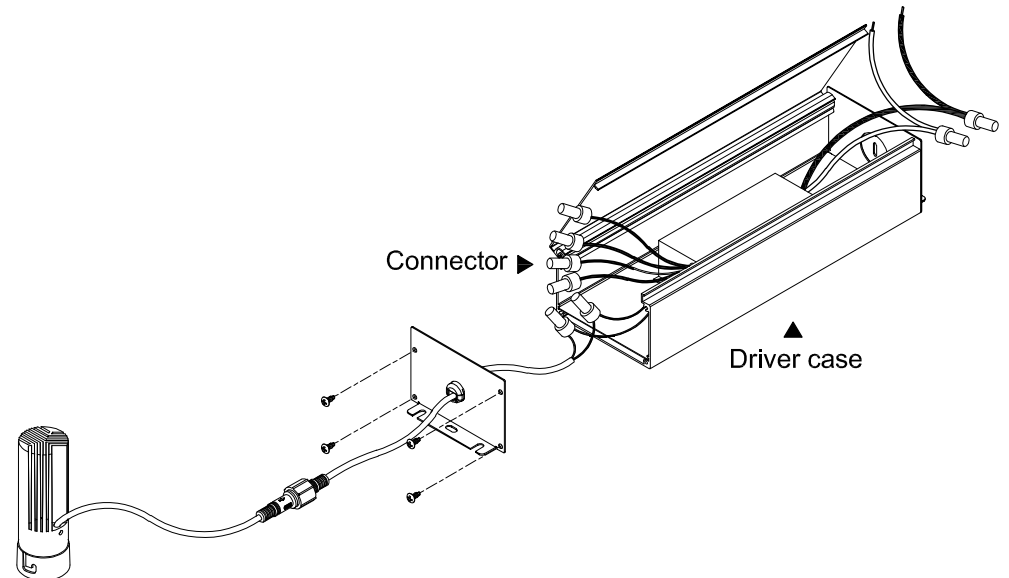

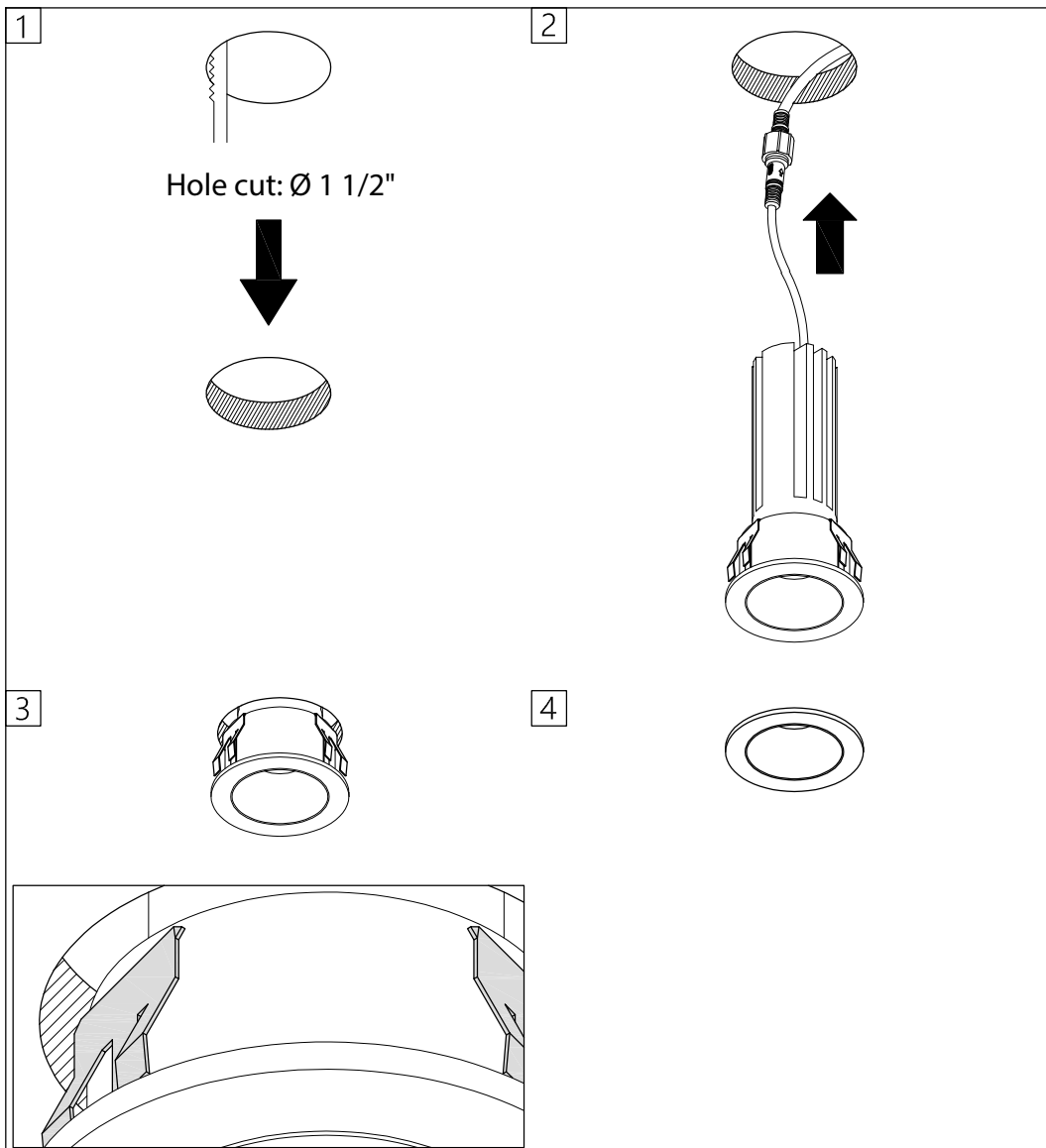

### TRIM WITH FLANGE

1. Make holes in the ceiling to match the size of the lighting fixture.  
(※ Check the size of the lighting fixture and the free space on the ceiling.)
2. Connect the power (AC120) line and driver and insert them into the ceiling.
3. Push the lighting fixture into the ceiling and secure the lighting fixture.  
Then, the moment the spring is pushed into the ceiling, it is pushed tightly on both sides and the lighting fixture is fixed.  
(※ Be sure to check whether the device is completely fixed.)

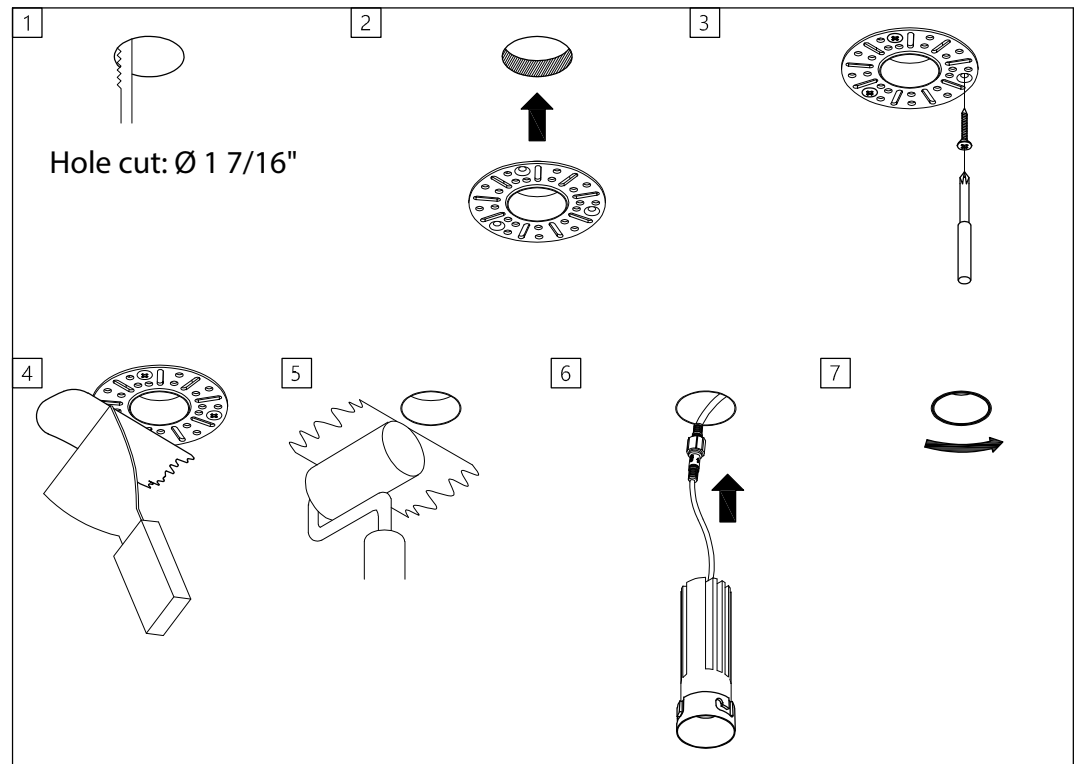

### TRIM FLANGELESS

1. Make holes in the ceiling to match the size of the lighting fixture.  
(※ Check the size of the lighting fixture and the free space on the ceiling.)
2. Insert accessory into the perforated part and secure it with 3 bolts.
3. After fixing, finish with putty work and paint as shown in the picture.
4. After painting is completed, connect the power (AC120) line and driver and insert it into the ceiling.
5. When inserting a lighting fixture, align the groove on the housing with the fixing device on, then turn to secure the lighting fixture.  
(※ Be sure to check whether the device is completely fixed.)
5. For the square type trimless, install it the same way as the picture above.  
However, in the case of a square, it can be cut to the desired length.

