

⚠ WARNING

1. Don't use at place that exists with vibration, impact corrosion or flammable gas and dust.
2. Don't use at place that is in high temperature as like sauna.
3. Only use designated LED.
4. Don't modify and change assembly of luminaires.
5. Don't light on when lighting fixture is damaged.
6. Connect power source line to LED driver
7. The luminaire shall only be used complete with it's protective.

⚠ CAUTION

1. When removing or attaching the reflector, do not touch it with your bare hands.
(※ Clean gloves or new gloves should be used since fingerprints may remain on the reflector)
2. The luminaire is not suitable for external installation.
3. Cables must not touch the luminaire housing.
4. To avoid risks, if this luminaire has a damaged external flexible cable, it must only be replaced by the manufacturer, his service agent or qualified technician.
5. This sign  on the luminaire symbolizes the safety distance.
This safety distance is to be observed.
6. The luminaire must be switched-off and cool before being cleaned.
Note : Regular cleaning is essential. The interval and method will depend on the mounting location, the mounting situation and ambient conditions.
7. A dampened soft cloth is to be used.
8. Use a soft cloth and a standard pH neutral, alcohol free non-scouring detergent.
Ensure wire color : (+) red, (-) black
9. Use a soft cloth and a standard pH neutral, non scouring detergent.
10. Do not make a circuit with other lighting fixtures which have different light source like discharge lamp & etc.



This marking shown on the product or its literature, indicates that it should not be disposed with other household wastes at the end of its working life. To prevent possible harm to the environment or human health from uncontrolled waste disposal, please separate this from other types of wastes and recycle it responsibly to promote the sustainable reuse of material resources.

Household users should contact either the retailer where they purchased this product, or their local government office, for details of where and how they can take this item for environmentally safe recycling.
Business users should contact their supplier and check the terms and conditions of the purchase contract, This product should not be mixed with other commercial wastes for disposal.

SAFETY MARKS



Minimum distance below ceiling of 1.64 ft between lamp and any combustible materials.

The luminaire can be installed with minor obstructions such as timber beams above the ceiling within 4"-8" distance.



The luminaire must not under and circumstances be covered with heat insulating covers or similar materials.



For direct mounting on normally flammable surfaces

※ Before you use, please read this information and use correctly.



Product Family: ASTRA

INSTALLATION INSTRUCTIONS SAFETY INFORMATION

Luminaire Assembly **AST-19-AD-TWF**

※ To change size depending on options.

THE ELECTRICAL CONNECTION MUST BE MADE BY AN ELECTRICIAN

MAKE SURE THE POWER SUPPLY IS TURNED OFF AT THE FUSE BOARD BEFORE MAKING THE ELECTRICAL CONNECTION.

THE ELECTRICAL CONNECTION AND INSTALLATION CAN BE DONE FROM THE ROOM.

ELECTRICAL CONNECTIONS:

1. Open the junction box
2. Connect the wires coming out of the junction box to the power supply accordingly.

Black - voltage
White - neutral
Green - ground wire



NOTE GROUNDING : Many structures are grounded through steel conduit. In this case, if there is no grounding wire, leave the green wire of the green wire from the fixture unattached.

3. Cover the connections with safety caps.
4. Finally continue with the installation.

► Electrical Connections

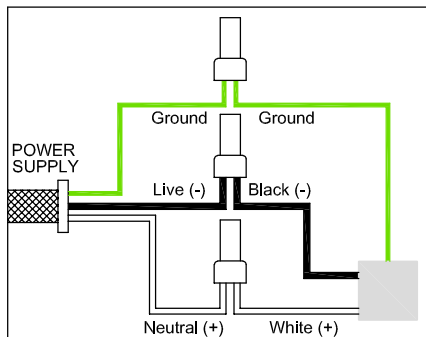

► Wiring Diagram

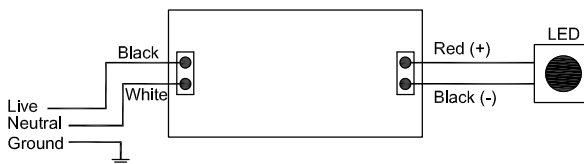

[Connect wires accordingly]

- Black (120-277V) = Supply Voltage
- White = Neutral
- Green or copper wire = Grounding Junction Box Wire

DRIVER CONNECTION AND SPACING

1. Keep the distance between the light fixture and the driver as much as possible.
2. The inside of the ceiling where the lighting fixture is to be installed, it is necessary to secure a minimum space for heat dissipation.

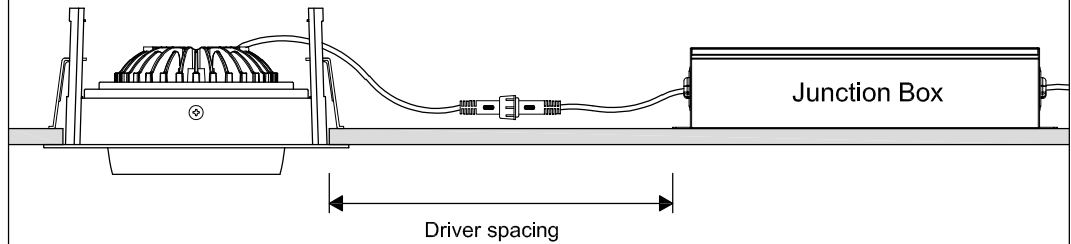

DRIVER ELECTRIC DIAGRAM

1. Detect the heat from the light fixture and lower the temperature.
2. Connect the driver and lighting fixtures through the terminal block.

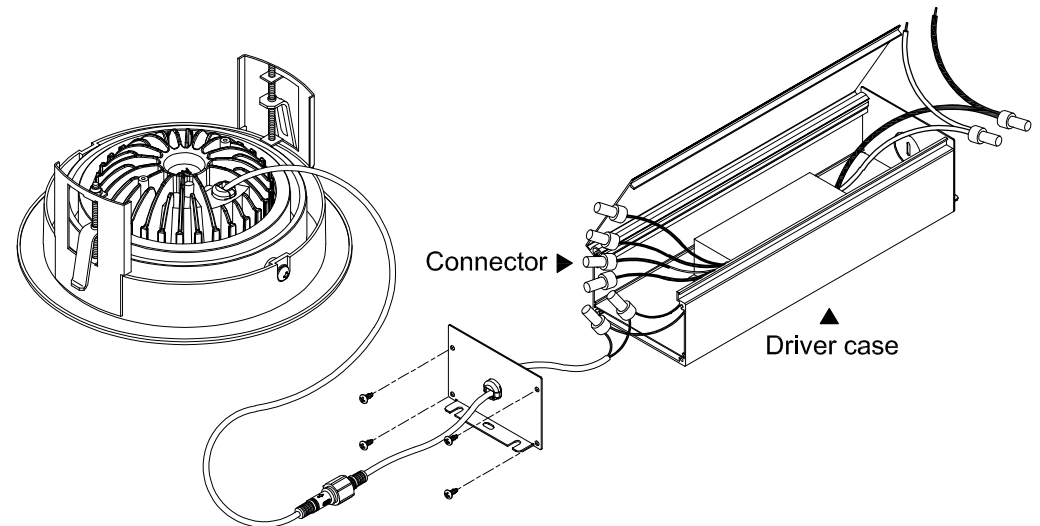

1

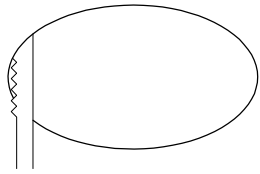

Hole cut: \varnothing 6 1/2"

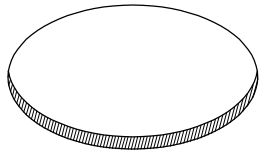
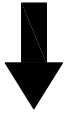

2

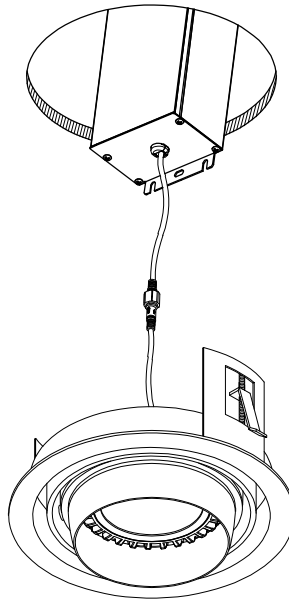

3

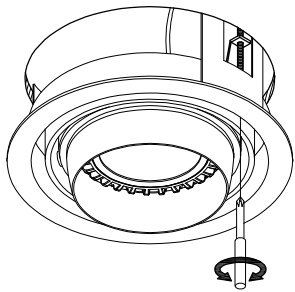

4

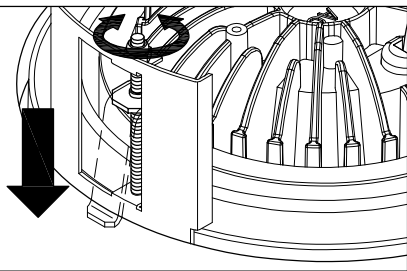
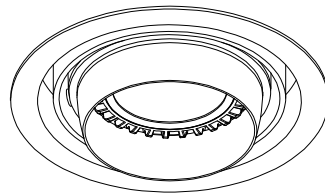

INSTALLATION:

1. Perforate the ceiling according to the size of the lighting fixture.
2. Connect the power supply (AC220) wire and the driver and put it in the ceiling.
3. Before placing the light fixture in the ceiling, turn the fixing bracket into the fixture.
4. Connect the driver connector placed in the ceiling and the connector on the light fixture.
5. Insert the lamp with the connected connector and fix the fixing bracket by turning the bolt with a screwdriver.