

⚠ WARNING

1. Don't use in location that exists with vibration, impact corrosion or flammable gas and dust.
2. Don't use in location that is in high temperature as like sauna.
3. Only use designated LED.
4. Don't modify and change assembly of luminaires.
5. Do not turn on when lighting fixture is damaged.
6. Connect power source line to LED driver certified according to en/iec 607 42.

⚠ CAUTION

1. When removing or attaching the reflector, do not touch it with bare hands.
(Clean gloves or new gloves should be used as fingerprints may be left on the reflector)
2. The luminaire is not suitable for outdoor installation.
3. To avoid fire and electric shock hazards, if this luminaire has damaged external flexible wiring, it should only be replaced by the manufacturer or its service agent.
4. Use a soft, damp cloth; and a standard nonalcoholic, pHneutral detergent.
Make sure of the color of the wires : (+) red, (-) black.
5. The luminaire must be turned off and cool before cleaned.
Note : Periodic cleaning is essential. The interval and method will depend on the mounting location, mounting situation and ambient conditions.
6. Do not connect to the branch circuit with other lighting fixtures which have different light source like discharge lamp & etc.

 This marking shown on the product or its literature, indicates that it should not be disposed with other household wastes at the end of its working life. To prevent possible harm to the environment or human health from uncontrolled waste disposal, please separate this from other types of wastes and recycle it responsibly to promote the sustainable reuse of material resources.

Household users should contact either the retailer where they purchased this product, or their local government office, for details of where and how they can take this item for environmentally safe recycling.
Business users should contact their supplier and check the terms and conditions of the purchase contract, This product should not be mixed with other commercial wastes for disposal.

SAFETY MARKS



Minimum distance below ceiling of 1.64 ft between lamp and any combustible materials.

The luminaire can be installed with minor obstructions such as timber beams above the ceiling within 4"-8" distance.



The luminaire must not under and circumstances be covered with heat insulating covers or similar materials.



For direct mounting on normally flammable surfaces

※ Before you use, please read this information and use correctly.



Product Family: ALFA

INSTALLATION INSTRUCTIONS SAFETY INFORMATION

Luminaire Assembly **ALF-14-DI-TWF**

※ To change size depending on options.

THE ELECTRICAL CONNECTION MUST BE MADE BY AN ELECTRICIAN

MAKE SURE THE POWER SUPPLY IS TURNED OFF AT THE FUSE BOARD BEFORE MAKING THE ELECTRICAL CONNECTION.

THE ELECTRICAL CONNECTION AND INSTALLATION CAN BE DONE FROM THE ROOM.

ELECTRICAL CONNECTIONS:

1. Open the junction box
2. Connect the wires coming out of the junction box to the power supply accordingly.

Black - voltage
White - neutral
Green - ground wire



NOTE GROUNDING : Many structures are grounded through steel conduit. In this case, if there is no grounding wire, leave the green wire of the green wire from the fixture unattached.

3. Cover the connections with safety caps.
4. Finally continue with the installation.

► Electrical Connections

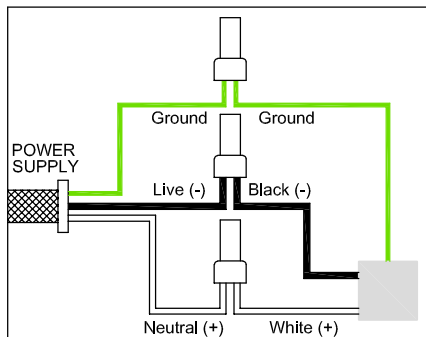

► Wiring Diagram

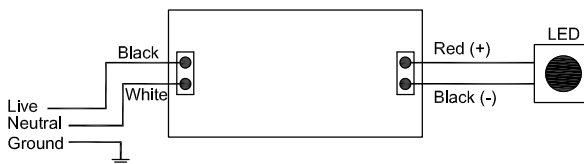

[Connect wires accordingly]

- Black (120-277V) = Supply Voltage
- White = Neutral
- Green or copper wire = Grounding Junction Box Wire

DRIVER CONNECTION AND SPACING

1. Keep the distance between the light fixture and the driver as much as possible.
2. The inside of the ceiling where the lighting fixture is to be installed, it is necessary to secure a minimum space for heat dissipation.

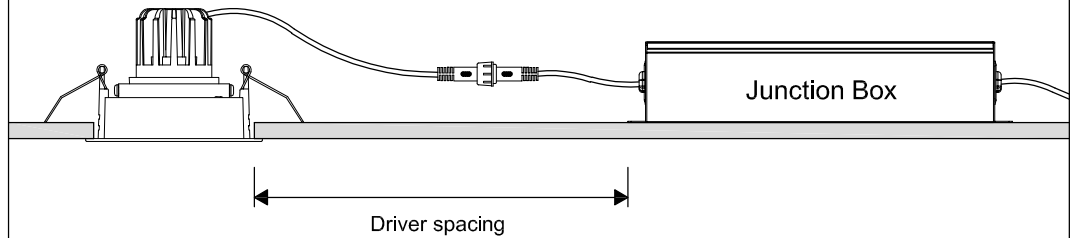

DRIVER ELECTRIC DIAGRAM

1. Detect the heat from the light fixture and lower the temperature.
2. Connect the driver and lighting fixtures through the terminal block.

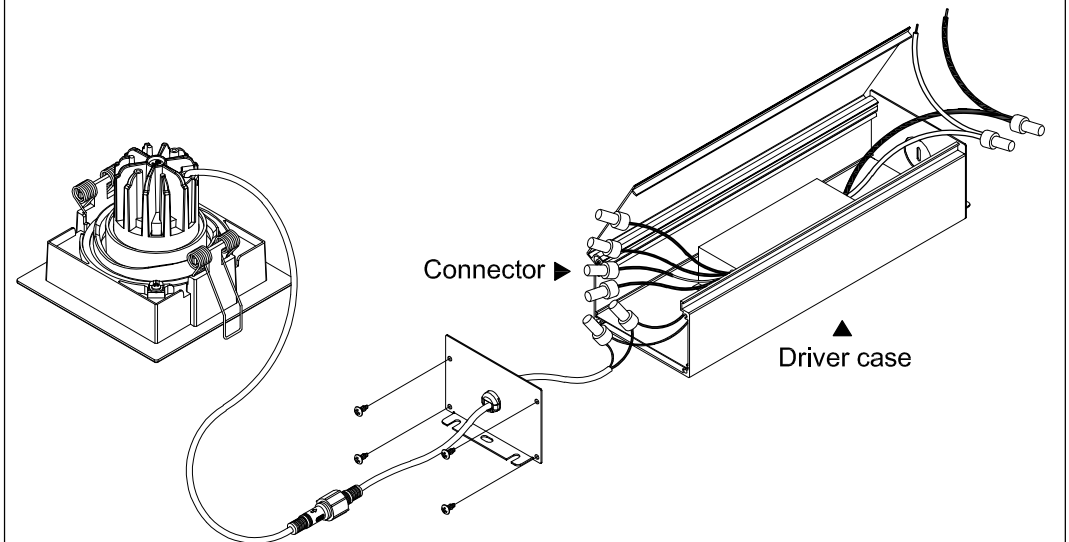

1

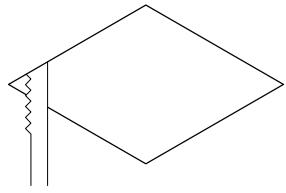

Hole cut: Ø 4" x 4"

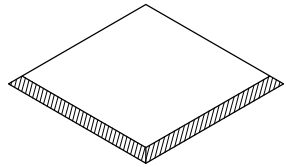

2

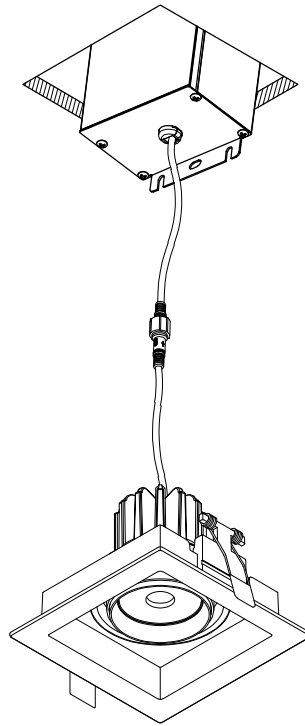

3

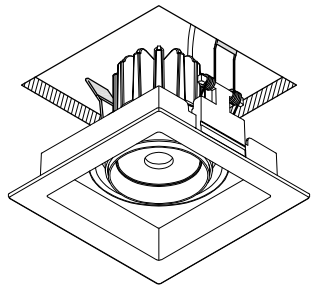

4

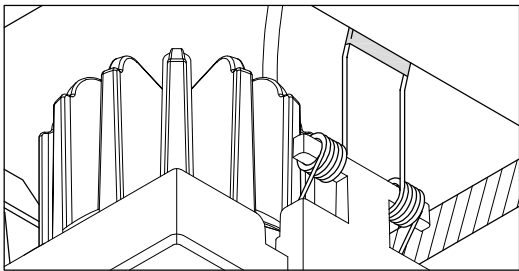
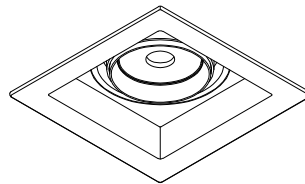

INSTALLATION:

1. Make a hole in the ceiling to the size to install the lighting fixture.
(※ Check the size of the lighting fixture and the free space on the ceiling.)
2. After connecting the driver connected to the lighting fixture to the power (AC120) line, insert it into the ceiling.
3. The spring attached to the lighting fixture spans both sides or one side of the perforated ceiling.
(Be sure to be careful as the strength of the spring is strong.)
4. When both springs are hung on the ceiling, push in the lighting fixture and fix the lighting fixture.
(※ Make sure that the instrument is completely fixed.)
(※ Be sure to hold the reflector with a clean cloth or gloves to minimize stains.)